

Design For Manufacture & Assembly

Boothroyd Dewhurst Inc, USA

COST Focused Product Design



DFMA in the Industry

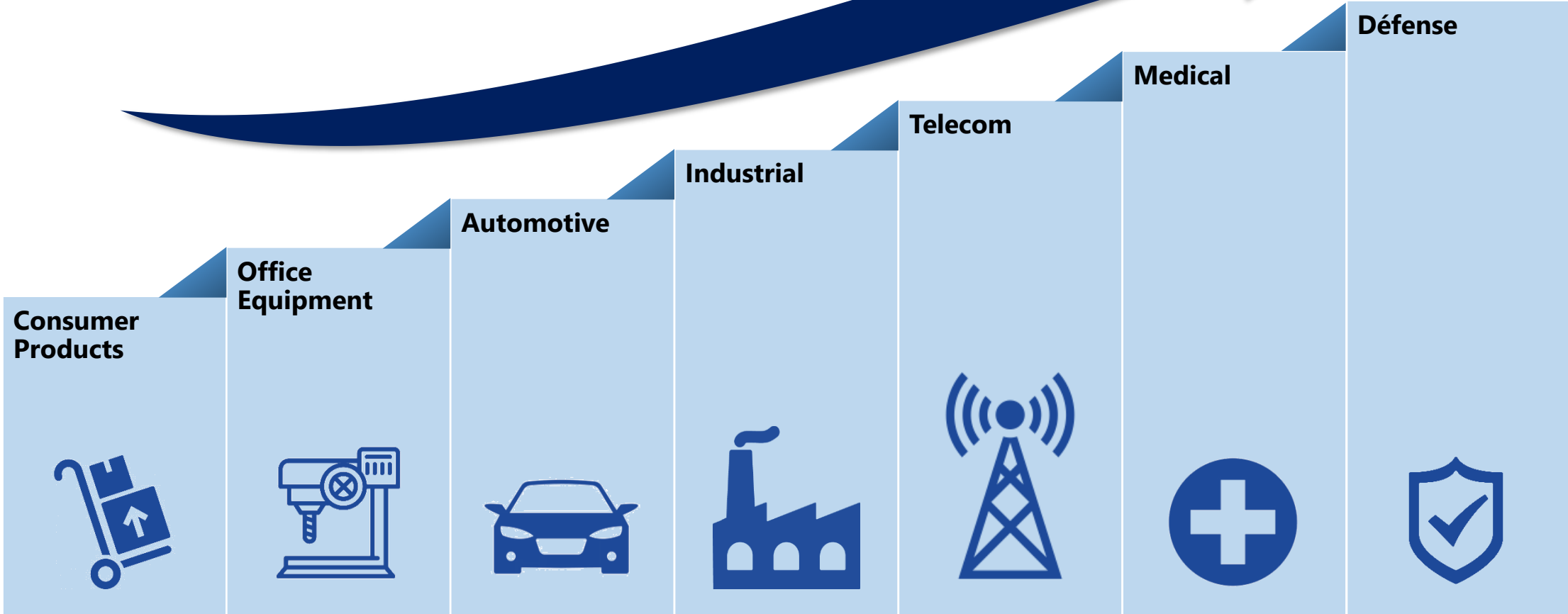

DFMA Support Areas

Development of New Products

Re-engineering the Existing products

Benchmarking Competitors Products

Accurate Cost Estimations

Quick Assembly Time Estimations

Design Trade-Off Decision Support



Why Design Engineers require DFMA? (1/2)



Design is the first step in manufacturing and is where most of the crucial decisions are made affecting the final cost of the product

Design Engineers need to take decisions to optimize or Economize the design of Mechanical/Electrical/Electronic equipment. They have to do this to remain competitive

Why Design Engineers require DFMA? (2/2)



DFMA® has created a revolution in manufacturing leading to...

- ✓ Reduced product cost
- ✓ Improved quality and reliability
- ✓ Shorter time-to-market
- ✓ Lower stocks
- ✓ Fewer suppliers and
- ✓ Many other benefits

DFMA® is a software tool with 42 years of Existence

DFMA® has a largest database of industry best practices

DFMA® has these in the most user-friendly GUI



DFMA has Two Modules

Design for Assembly (DFA)

Product Simplification

Design for Manufacturing (DFM)

Concurrent Costing



Average Reductions using DFMA



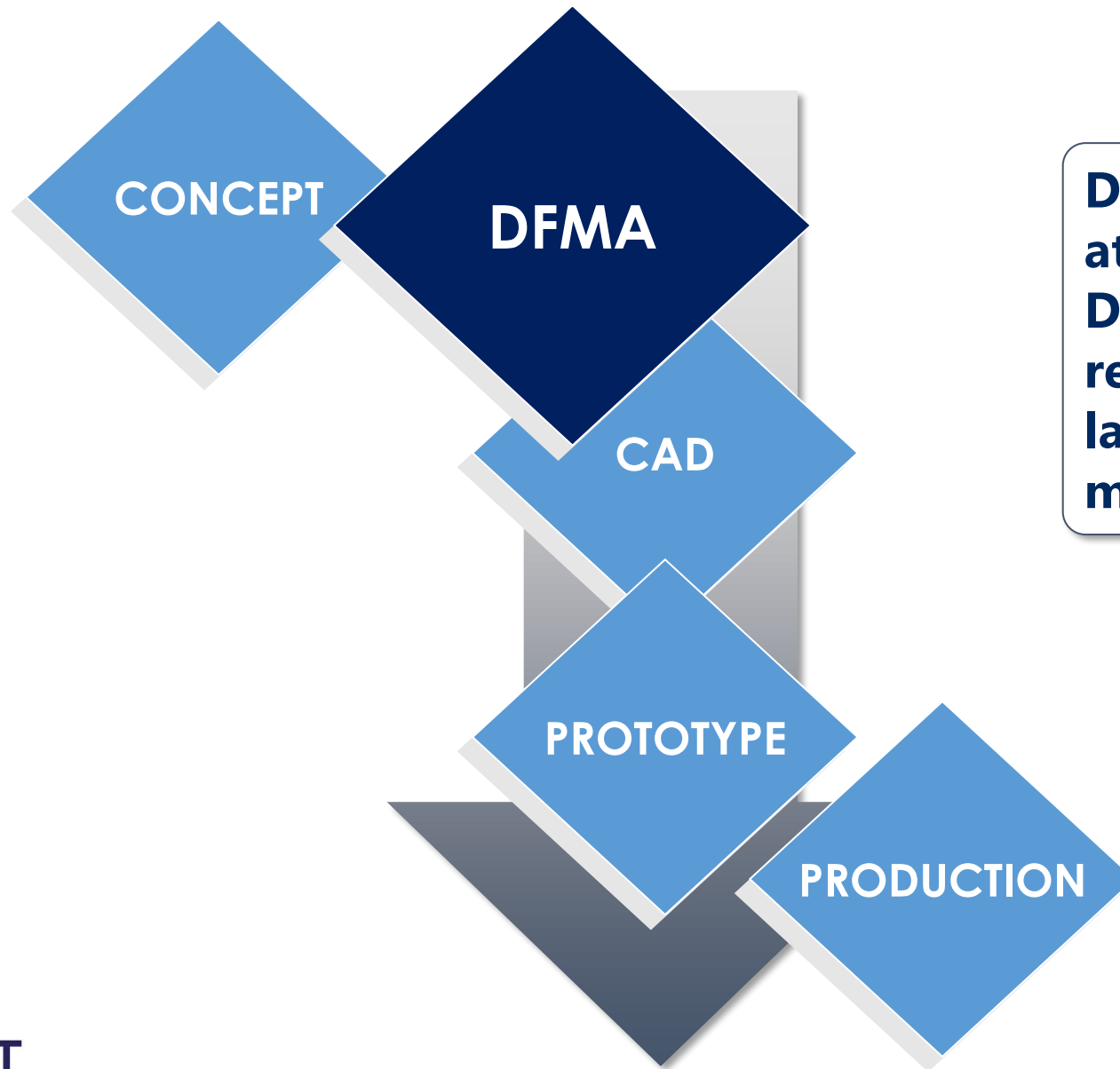

DFMA introduced at the top of the DESIGN cycle can reduce product launch times by more than 50%

Commercial Clients – OEM/ODM

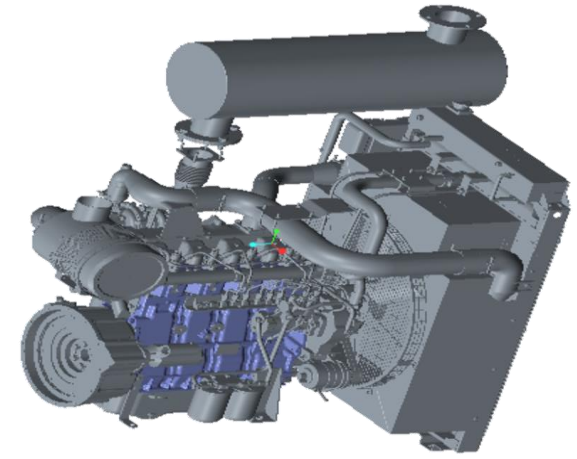

United Technologies Corporation, Bengaluru

Collins Aerospace, Bengaluru

Whirlpool GTEC, Pune

HAL- ARDC, Bangalore

Caterpillar, Chennai

Lucas TVS, Chennai

Covidien Medical, Hyderabad

Mahindra & Mahindra, Mumbai

DORMA India, Chennai

Rexnord, Hyderabad

DRDL, Hyderabad

Sanmina SCI , Chennai

EATON Technologies , Pune

Greaves Cotton, Pune

Commercial Clients – Engineering Services

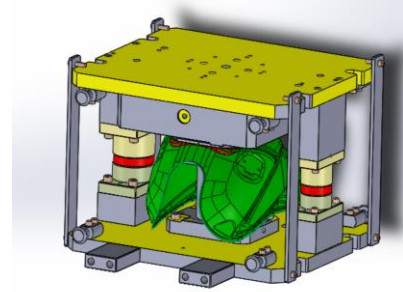

Cyient , Hyderabad

HCL Technologies , Bangalore

Tata Elxsi,Pune

Infosys Technologies Ltd, Bangalore

Infotech Enterprises Limited, Hyderabad

Larsen & Toubro, e-Engineering Services, Chennai

Onward Technologies, Pune

Quest Global Engineering Services, Bangalore

RGBSI, Bengaluru

Satyam-Venture Engineering Services, Hyderabad

Tata Consultancy Services, Bangalore & Pune

Tata Technologies.Pune

Vignani Technologies, Bangalore

Wipro, Hyderabad

OUR MISSION

To assist to move up on Innovation Index through awareness and deployment to the Design Community on Product Review & Early Manufacturing Analysis method - DFMA

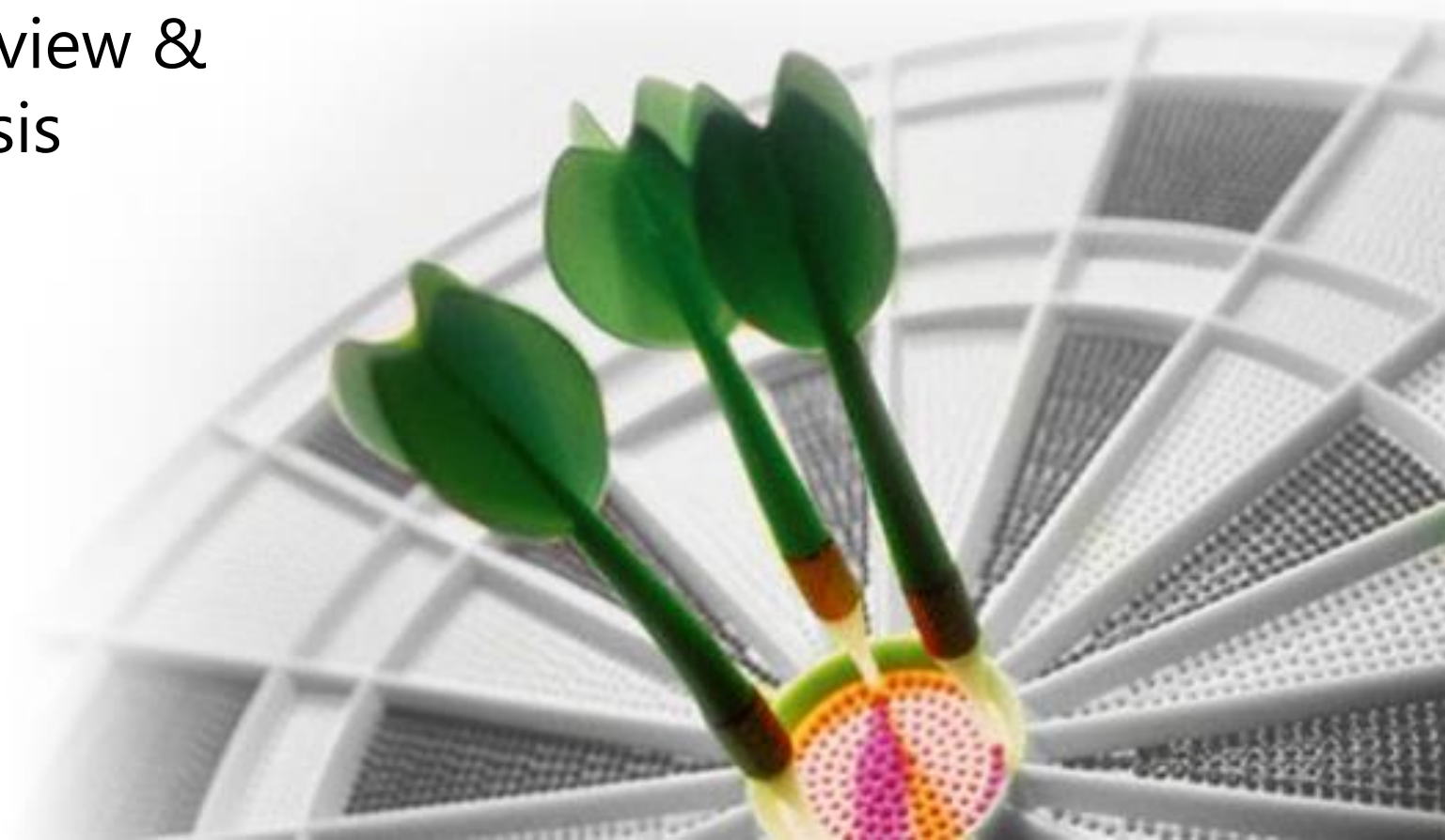

Our services are...

D-ESPAT Pvt Ltd, Chennai is a "SHOULD COSTING" consulting company .

We assist new product initiatives with Cost Reduction Strategies.

D-ESPAT is associated with Boothroyd Dewhurst Incorporation, USA, the Pioneering Principals of the Design For Manufacture & Assembly Methodology for their flagship software product DFMA®.



DFMA Software

DFMA Training

DFMA consultancy

Write to us at support@despat.com for Free Video Introduction to DFM & DFA Software

Design for Manufacture

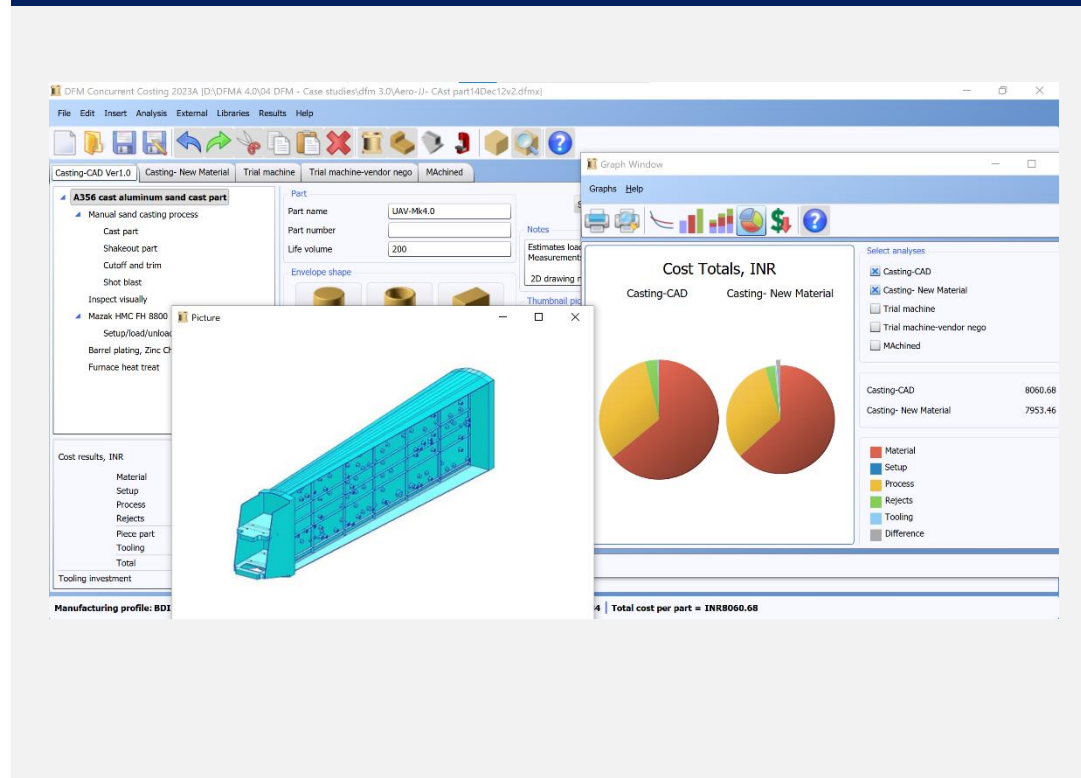

Design For Assembly

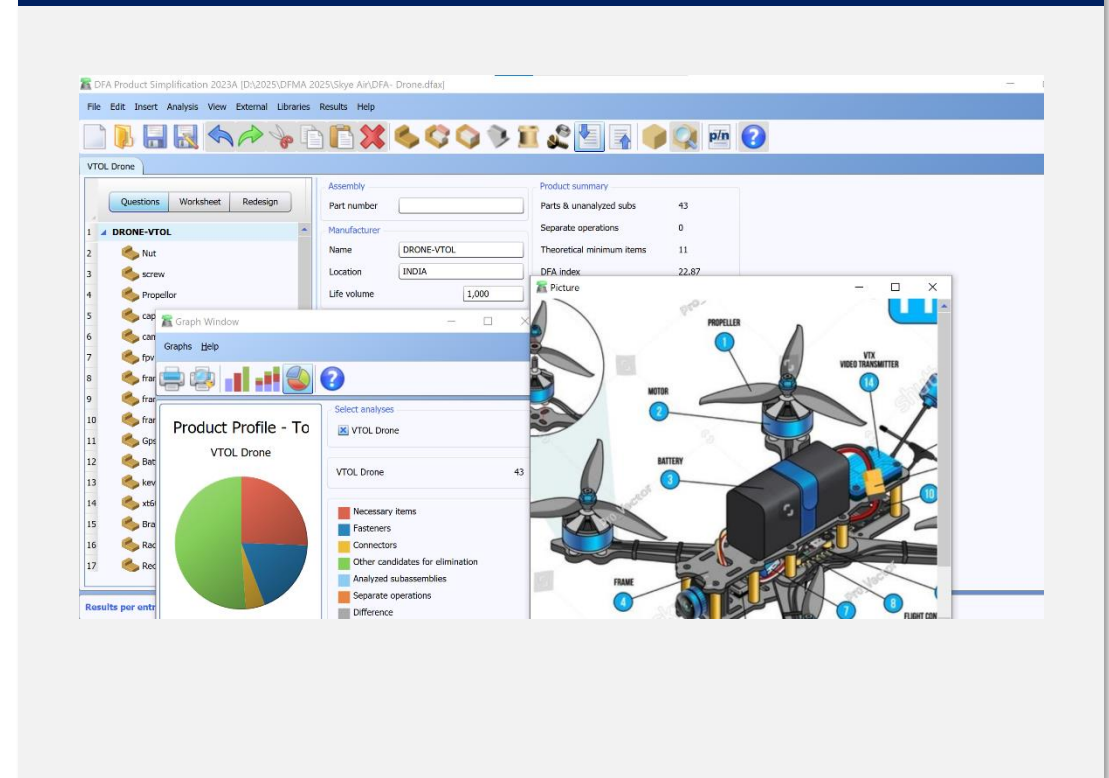

About D-Espat , Chennai

WHAT WE DO @ D.ESPAT

1

Lithium Ion – Custom Batteries

- D-Espat Pvt Ltd is a “Design House” for custom Lithium ion batteries
- We integrate unique Energy Storage Solutions for
 - Medical
 - Industry
 - Electric Vehicles
 - Strategic and Critical applications
- Product Design-through-Production
- Testing & Integration to Host Device
- Industrial and military applications in India

2

Design for Manufacture & Assembly (DFMA)

- Cost Reduction Strategy
 - Target Costing
 - Should-Be Costing
 - Supplier Costing
 - Product Simplification
- Design Review
- Early Manufacturing Analysis
- Product design - Cost Reduction & Simplification
- Re-Engineering & Value Engineering projects
- Training with Deployment of DFMA® Software

22

YEARS

of Design and
Development
of Lithium Ion
Batteries



13 years
“In-House” R&D
Recognized by
DSIR, DST, India

22

YEARS

of DFMA[®]
exclusive
distributorship*
in India &
SE-Asia

Thank you

Thank you

DFMA
Product Costing

Li-ion 
Custom Solutions

www.despat.com | www.despat.co.in